









Código	Diseño	Descripción	kg/m Pág.
ADR 910		Contravidrio recto de 8 mm	0,211
ADR 913		Contravidrio recto de 12 mm	0,214
ADR 1284		Guía postiza para alzante	0,214
ADR 1298		Tapajuntas de atornillar	0,312
ADR 2900		Marco	2,051
ADR 2901		Guía	0,637
ADR 2902		Hoja	1,608
ADR 2903		Parante central	1,243
ADR 2904		Contravidrio suplemento	0,777
ADR 2905		Tapa hoja	0,304
ADR 3187		Postizo marco	0,165

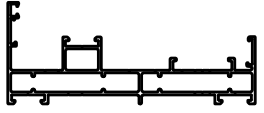
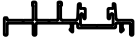
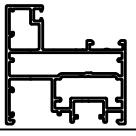
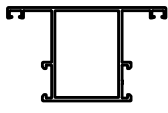

ADR 2900 Marco
2,051 kg/m

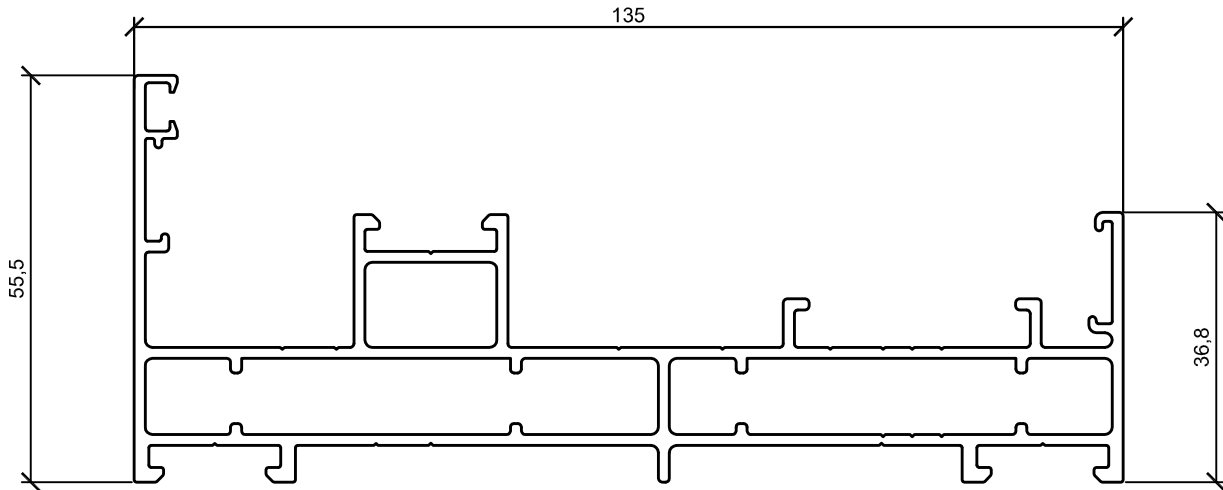

AA290
Alin. AA291

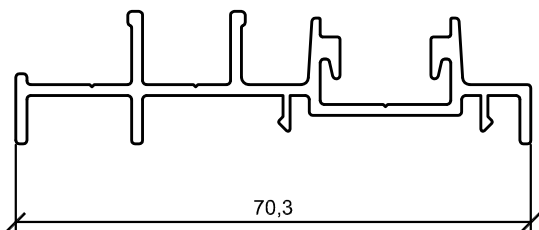

ADR 2901 Guía
0,637 kg/m

ADR 2902 Hoja
1,828 kg/m



AA290
Alin. AA291

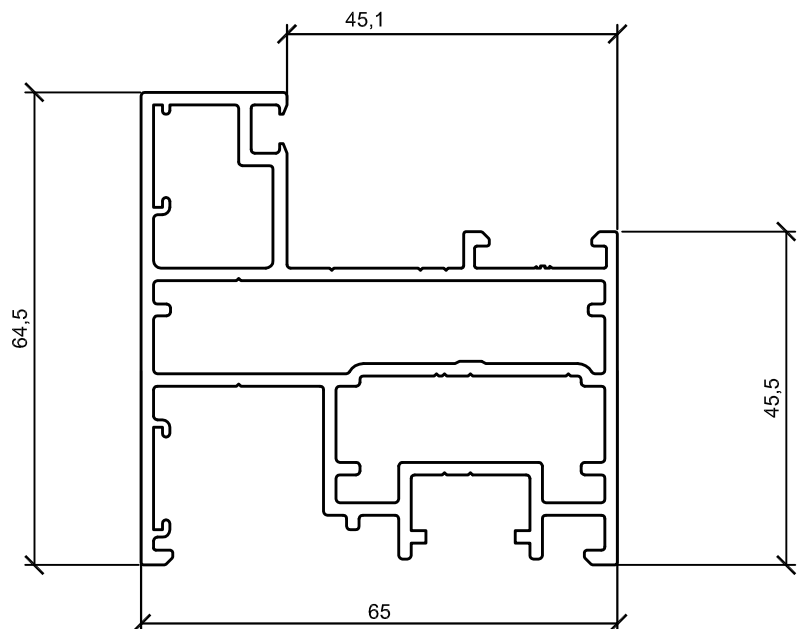

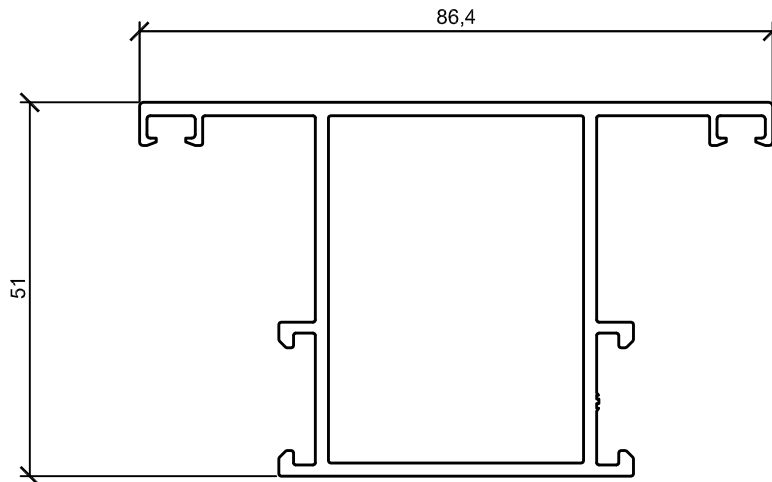

ADR 2903 Parante central
1,243 kg/m



AA290
Alin. AA291

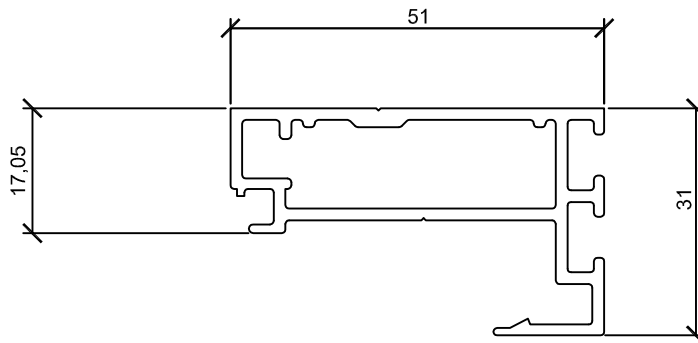

ADR 2904 Contravidrio suplemento
0,741 kg/m

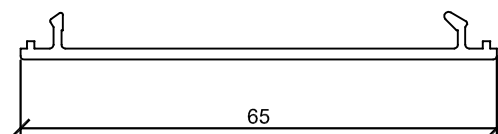

ADR 2905 Tapa hoja
0,304 kg/m

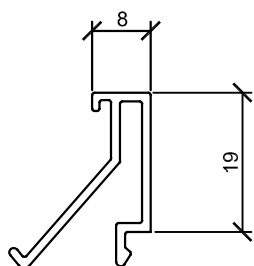

ADR 910 Contravidrio recto 8 mm
0,211 kg/m

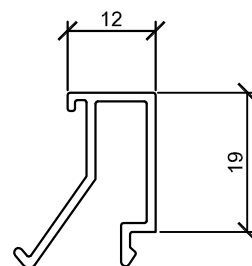

ADR 913 Contravidrio recto 12 mm
0,216 kg/m

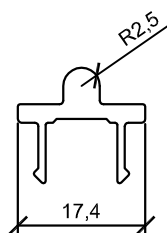



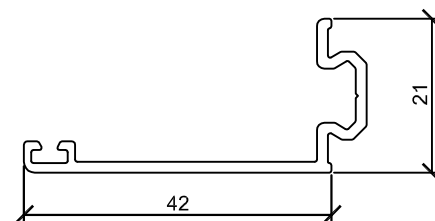



ADR 1283 Postizo guía alzante
0,214 kg/m









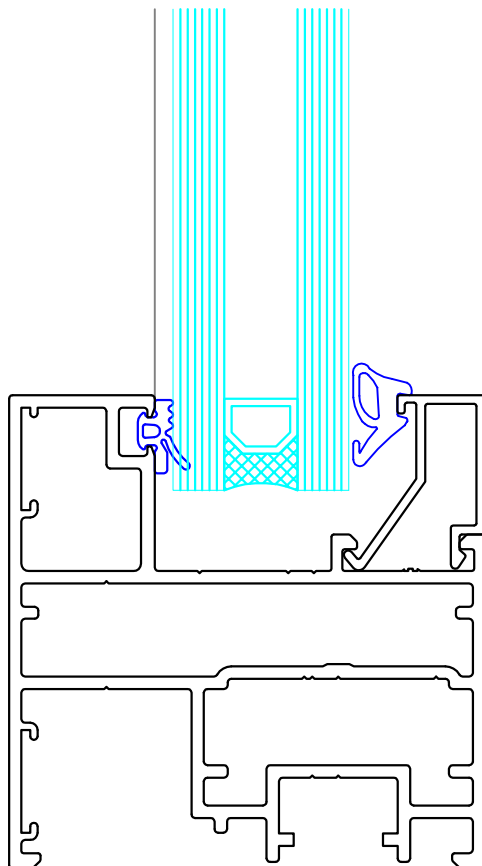

ADR 1298 Tapajuntas de atornillar
0,312 kg/m



ADR 3187 Postizo marco
0,165 kg/m

Guarnición exterior AG008E	Guarniciones interiores			
	AG226E	AG225E	AG556E	AG554E
				
 ADR 910	30	29	28	27
 ADR 913	26	25	24	23



Guarnición exterior AG008E	Guarniciones interiores			
	AG226E	AG225E	AG556E	AG554E
				
 ADR 910	31,5	30,5	29,5	28,5
 ADR 913	27,5	26,5	25,5	24,5

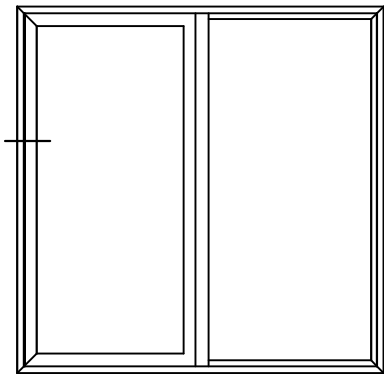

ADR 2900

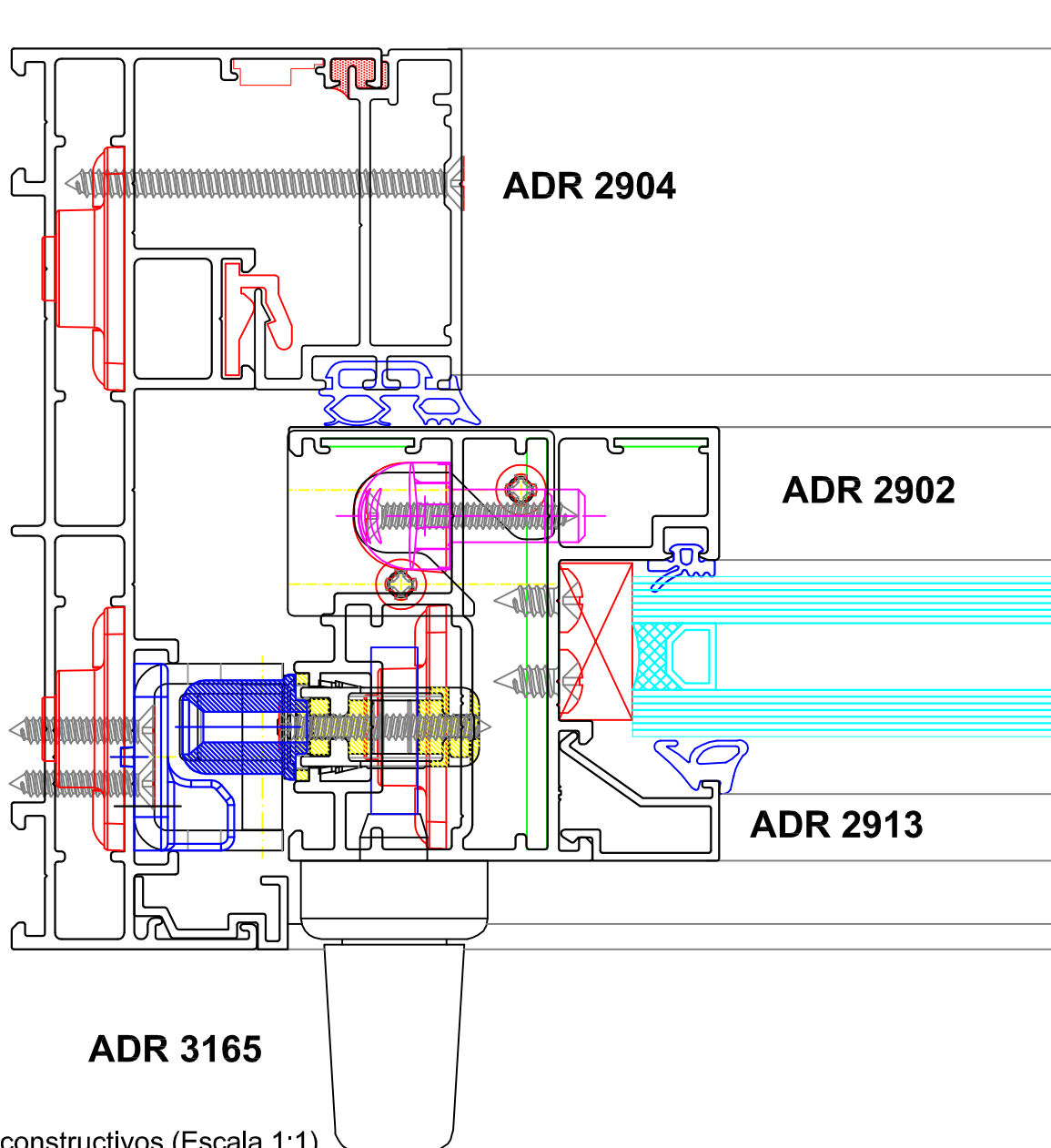

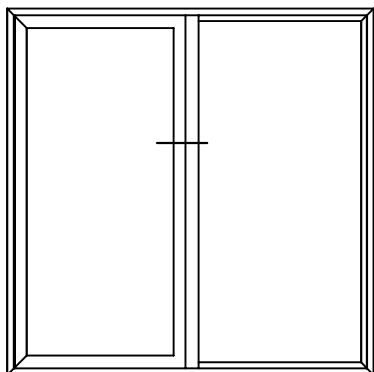

ADR 2903

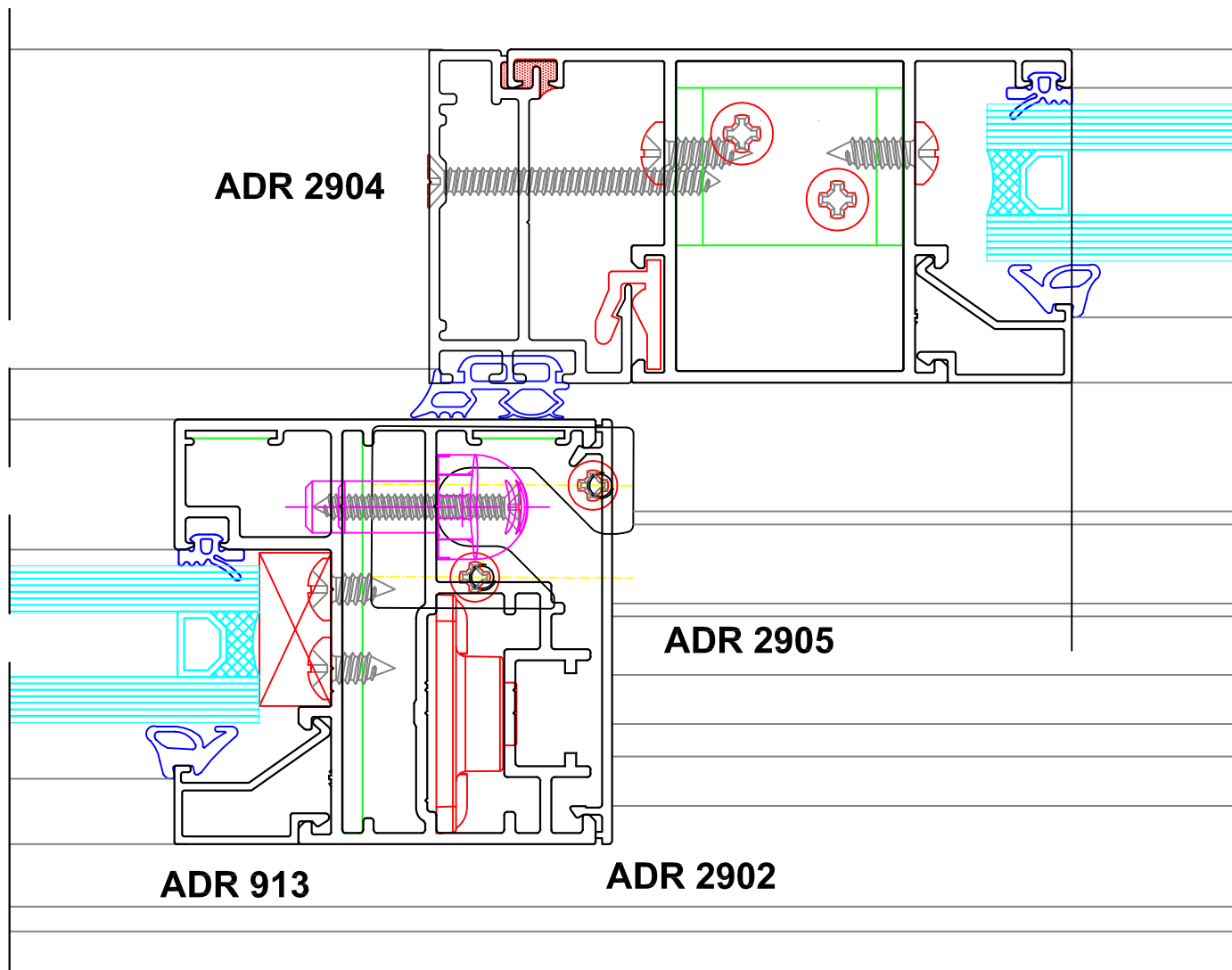

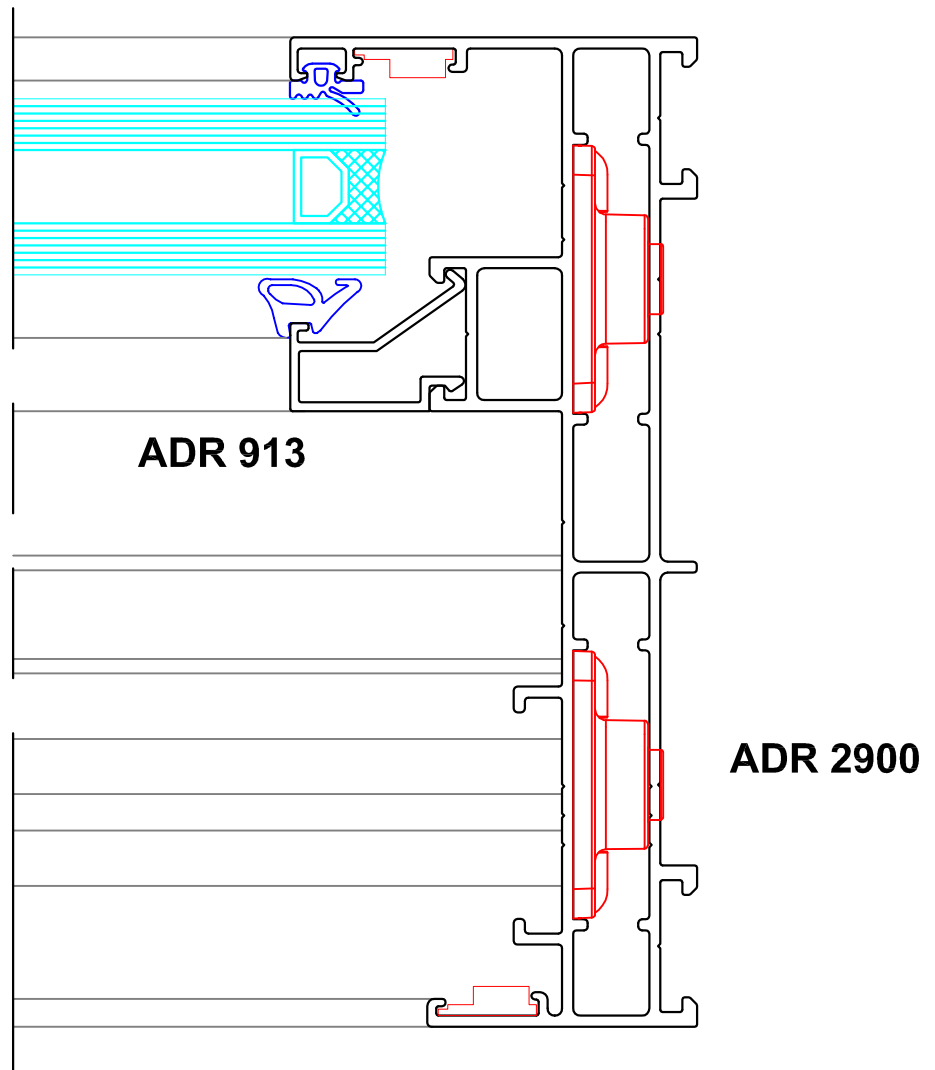
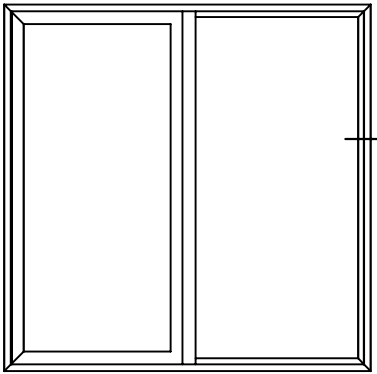

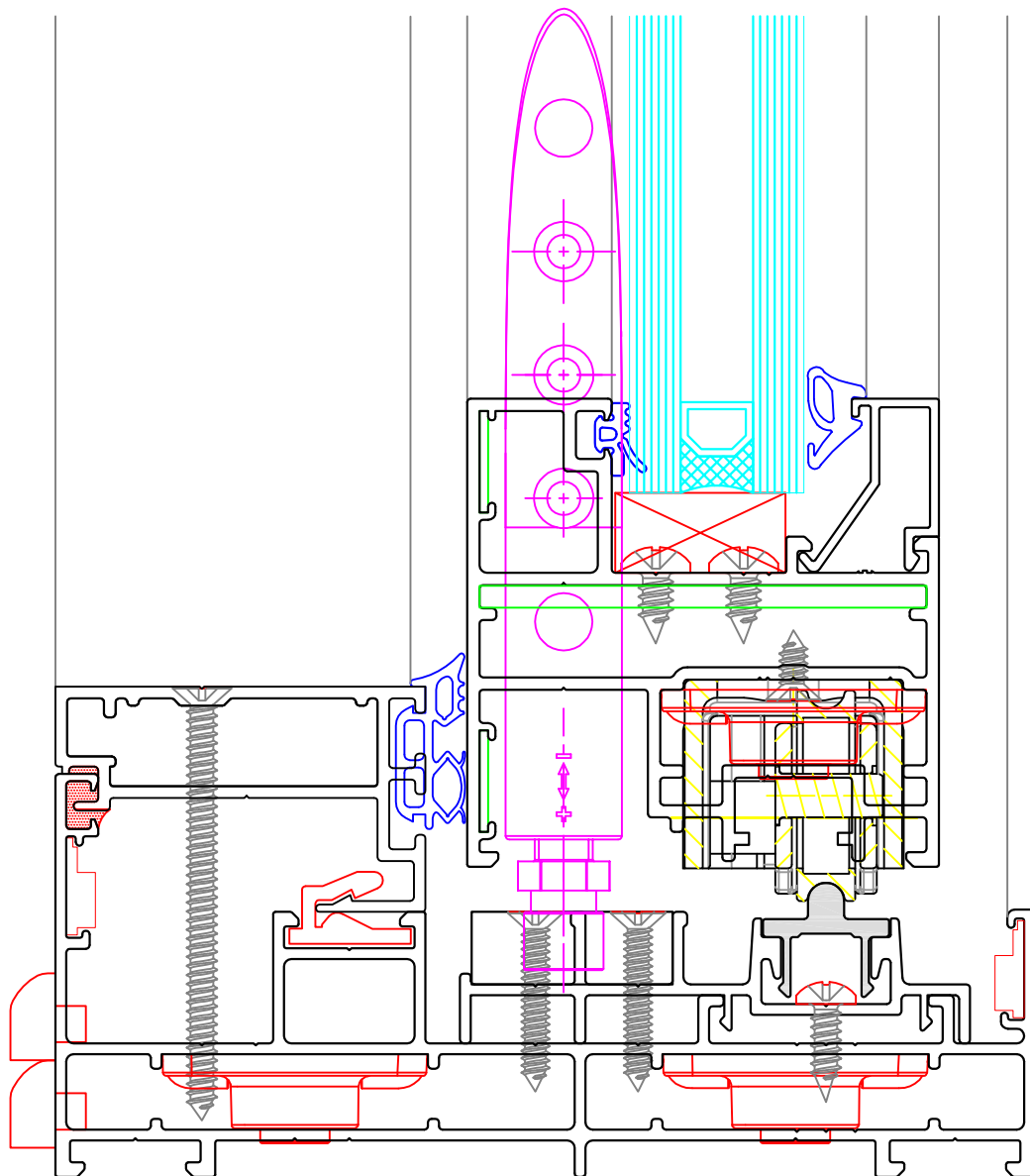
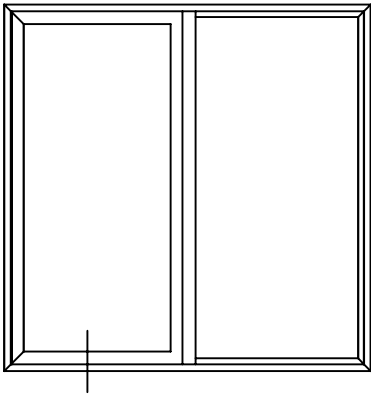

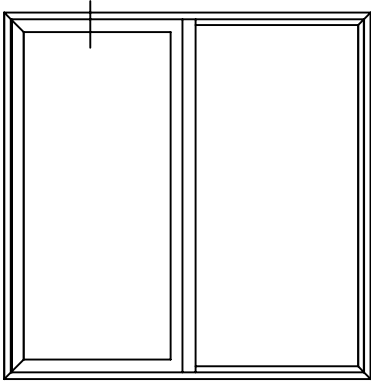

ADR 2984

ADR 2985

